

A (1:3)

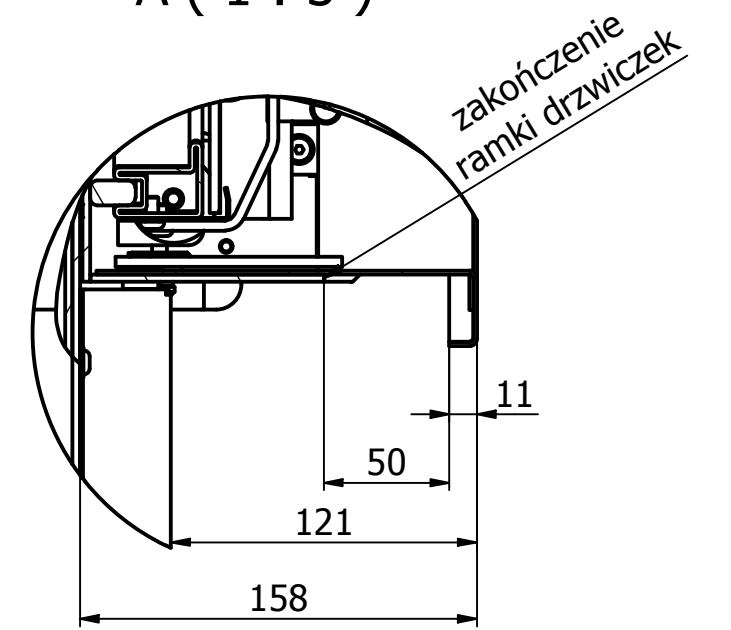

B (1:3)

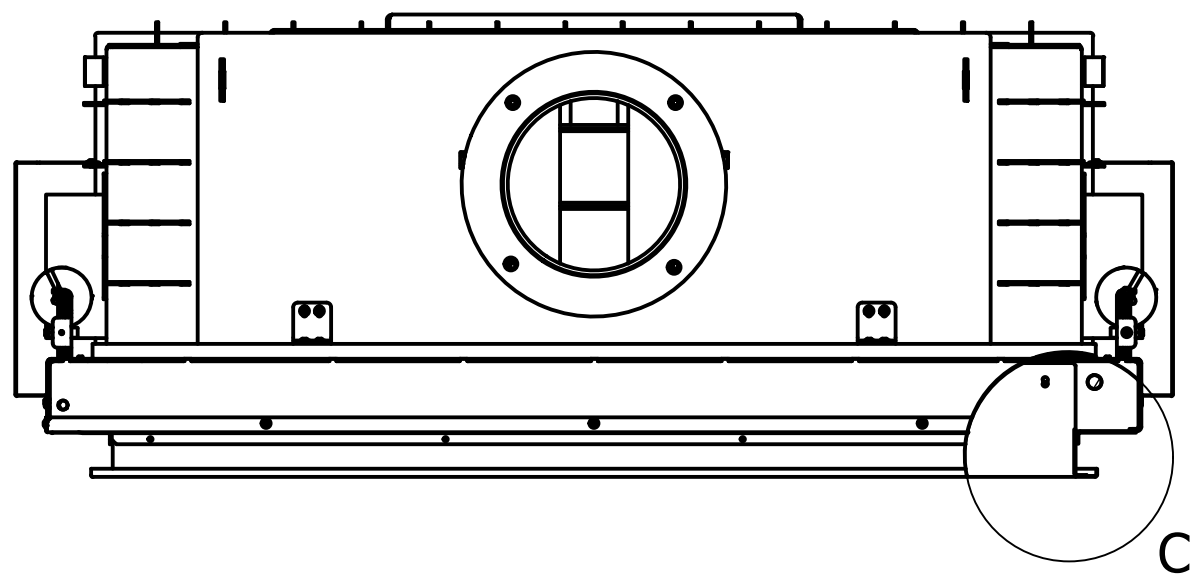
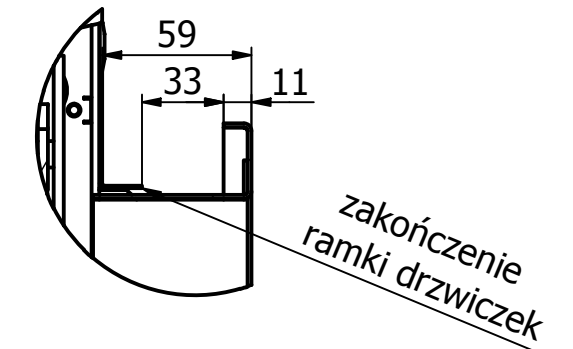

C (1:5)

